



OPTO ENGINEERING

ILLUMINATOR DATA

LTPVZE320X320D50-X-R-24V

Lighting Dimension

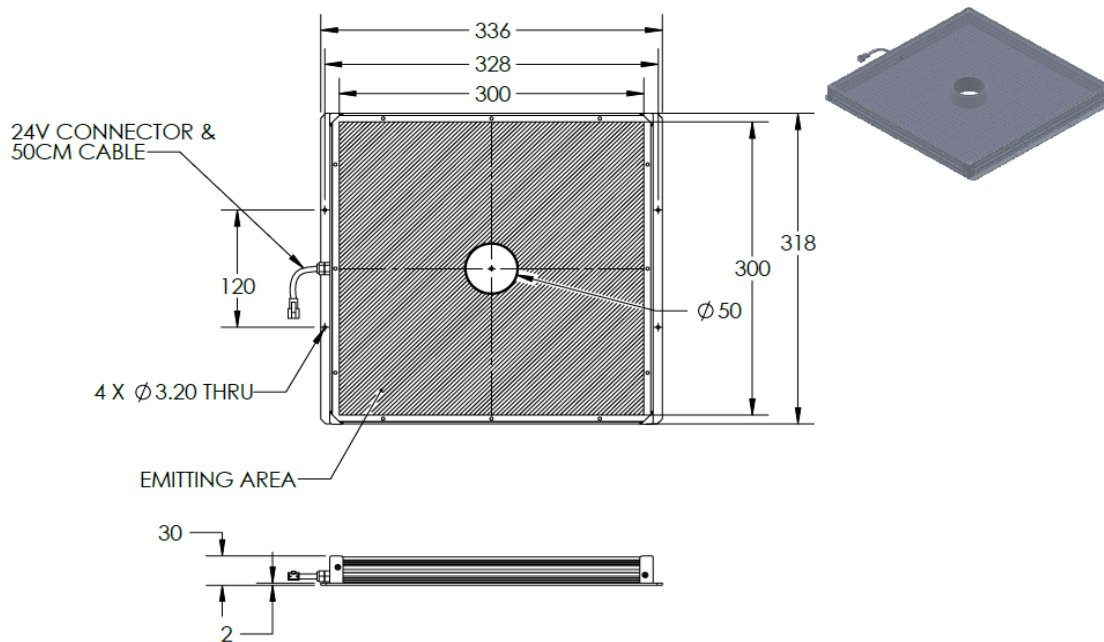

Mechanical Information

Casing Material	Aluminium
Storage Temperature Range	0 - 45°C
Storage Humidity Range	20 - 85%
Weight	1450g
Length / Outer Diameter	336mm
Width / Inner Diameter	318mm
Thickness / Height	30mm



OPTO ENGINEERING

ILLUMINATOR DATA

LTPVZE320X320D50-X-R-24V

Lighting Information																					
Part Number	LTPVZE320X320D50-X-R-24V																				
LED Color	RED																				
Wavelength	630																				
Working Distance	10 20 30																				
Intensity (±15%)	*FOR FURTHER INFORMATION PLEASE CONTACT US																				
Illumination (number of row)	X																				
Illumination Active Area	Active Length / Outer Dia. 320mm																				
	Active Width / Inner Dia. 320mm																				
Emission angle	0																				
Eye Safety Class (IEC62471)	EXEMPT																				
Chromaticity Table For White colour only	<table border="1"> <tbody> <tr> <td>X</td> <td>0.296</td> <td>0.287</td> <td>0.307</td> <td>0.311</td> <td>X</td> <td>0.311</td> <td>0.307</td> <td>0.33</td> <td>0.33</td> </tr> <tr> <td>Y</td> <td>0.276</td> <td>0.295</td> <td>0.315</td> <td>0.294</td> <td>Y</td> <td>0.294</td> <td>0.315</td> <td>0.339</td> <td>0.318</td> </tr> </tbody> </table>	X	0.296	0.287	0.307	0.311	X	0.311	0.307	0.33	0.33	Y	0.276	0.295	0.315	0.294	Y	0.294	0.315	0.339	0.318
X	0.296	0.287	0.307	0.311	X	0.311	0.307	0.33	0.33												
Y	0.276	0.295	0.315	0.294	Y	0.294	0.315	0.339	0.318												

Electrical Information	
Rated Constant Voltage	24V±2%
Rated Constant Current	2145mA
Power Consumption	51.48W
Casing temperature, After 60 minutes operation	52.4

Strobe Mode Specification	
*Normal Strobe Voltage	24 V
*Normal Strobe Current	2856mA
Overdrive Voltage Range	Min: 36V Max: 48V
Overdrive Current Range	Min: 3442mA Max: 4590mA
Recommended Overdrive Voltage	36V
**Max. Trigger Pulse Duration	10 msec
**Max. Duty Cycle	10%

*Normal strobe means the lighting is operated using the rated power. Overdrive means the power supplied to the lighting exceeded the rated power.

**Overdrive condition must not exceed the max. trigger pulse duration and max. duty cycle.

ILLUMINATOR DATA

LTPVZE320X320D50-X-R-24V

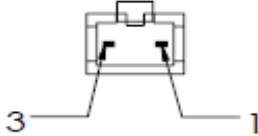
Connection Information			
Connector Type (Default)	JST SMR-03V		
Cable Length	50 cm		
Pin Configuration 	Pin	Signal	Cable Colour
	1	LED +	Red
	2	N.C	-
	3	LED -	White
			

Additional Information	
Additional Cooling Method	Attached to machine part for better heat dissipation
Intensity Controller Selection	SD, ST, ANG, LC, SDA, SDP series
CE Conformity	YES
RoHS Compliance	YES

Application	
Illumination Type	Diffused Illumination
Application Use	Robotic picking, identification & missing part, measurement, shape recognition



OPTO ENGINEERING

ILLUMINATOR DATA

LTPVZE320X320D50-X-R-24V

Lighting Pattern				
Working Distance	For further details please contact us.			
Display and Image				
Data Results	Horizontal	Meas.(mm)	Vertical	Meas.(mm)
	90%		90%	
	80%		80%	
	70%		70%	
	60%		60%	
	50%		50%	
	40%		40%	
	30%		30%	
	20%		20%	
	10%		10%	